

English

# 2-Wire Video Outdoor Station

---

User Manual

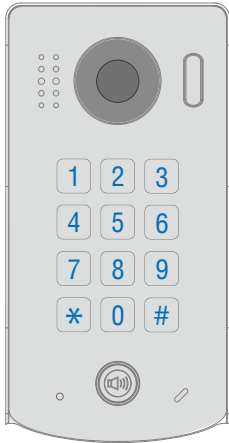

DT611/MK



DT611F/MK

# Contents

1.Parts and Functions.....	1
2.Terminal Descriptions .....	2
3.Mounting.....	2
4.System Wiring and Connections .....	3
5. Pan-tilt & Zoom .....	8
6. Functions Setting Up .....	9
7.Unlock Operations.....	16
8.Specifications .....	16
9.Cables Requirements .....	17
10.Precautions.....	18

# 1.Parts and Functions

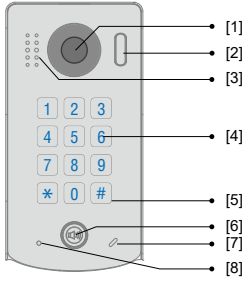

DT611/MK

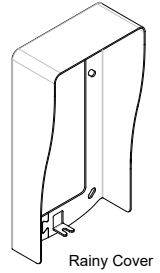
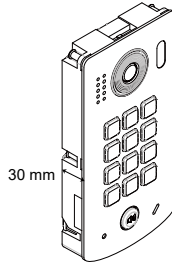

Rainy Cover

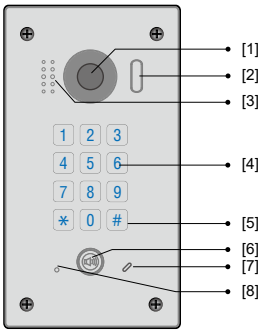

DT611F/MK

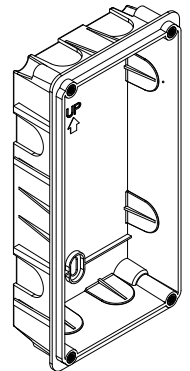
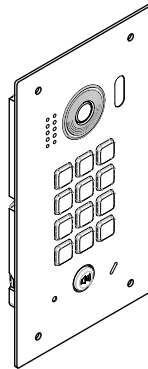

Mounting box

[1] Camera lens  
 [2] LED\_CAM  
 [3] Speaker

[4] KEY\_MK  
 [5] LED\_KEY  
 [6] Call button

[7] Microphone  
 [8] LED\_POW

## 2. Terminal Descriptions

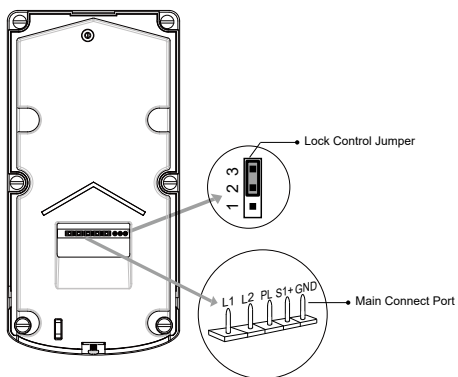

- **Lock Control Jumper:** To select the lock type.
- **Main Connect Port:** To connect the bus line and the electronic locks.
- **L1,L2:** Connect to the bus line, no polarity.
- **PL:** External lock power input, connect to the power positive(power +).
- **S1+,GND:** Lock power connection port.

## 3. Mounting

### DT611/MK Mounting

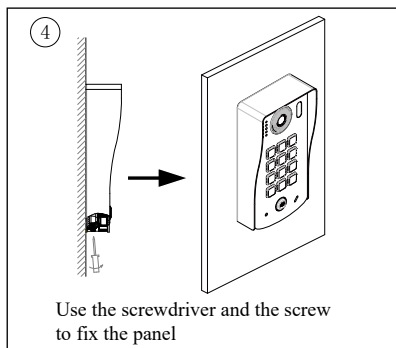
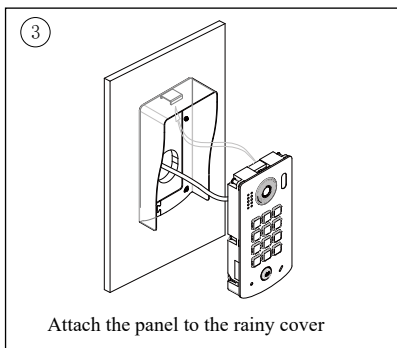
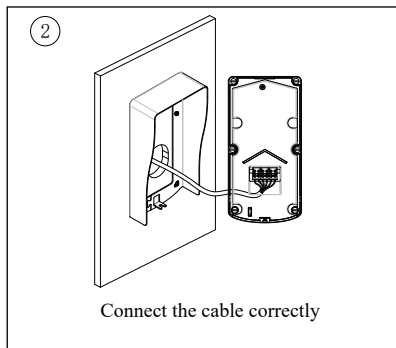
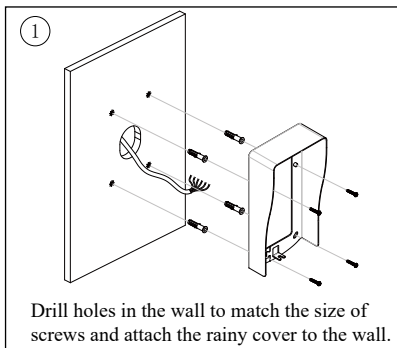

# DT611F/MK Mounting

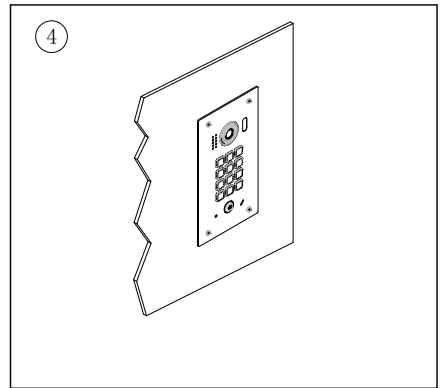
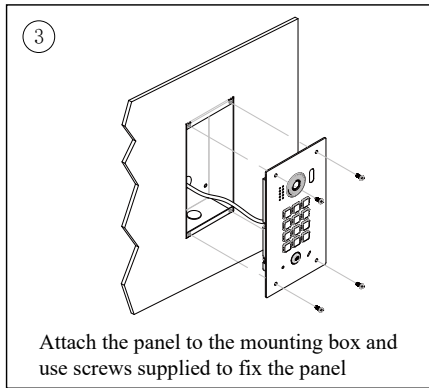
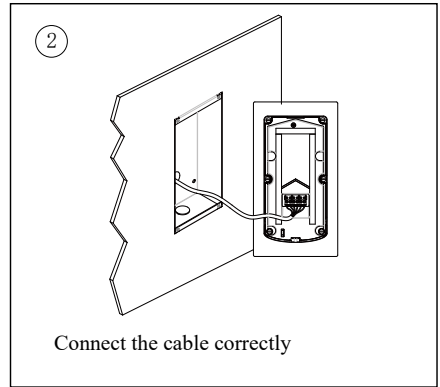
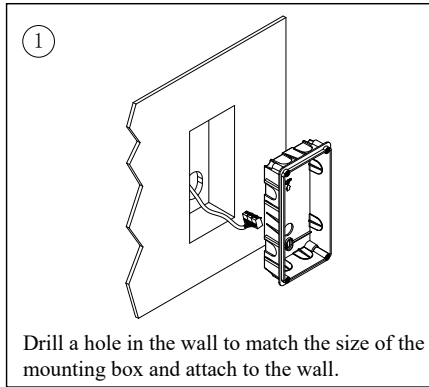

## 4. System Wiring and Connections

### Basic Connection

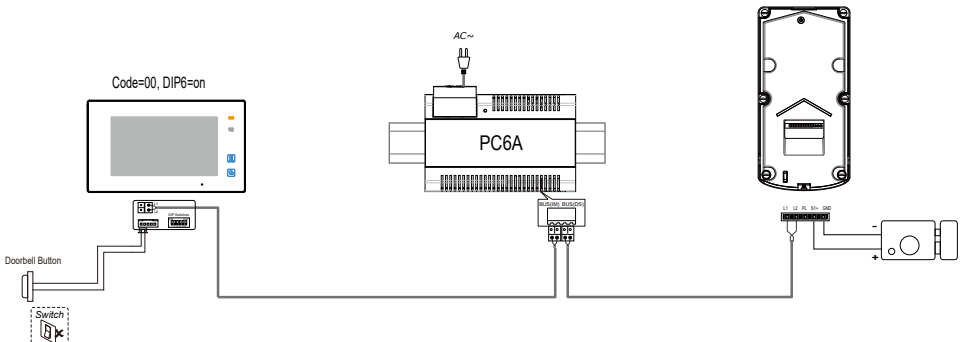

# Electric Lock Connection

## Door Lock Controlled with Internal Power

Note:

1. Electronic lock of Power-on-to-unlock type should be used.
2. The door lock is limited to 12V, and holding current must be less than 250mA.
3. The door lock control is not timed from Exit Button(EB).
4. The **Unlock Mode** Parameter of Monitor must be set to 0 (by default).

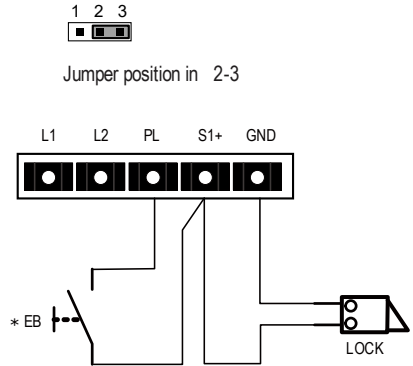

## Door Lock Controlled with Dry Contact

Note:

1. The external power supply must be used according to the lock.
2. The inside relay contact is restricted to AC or DC 24V/1A.
3. The jumper must be taken off before connecting.
4. Setup the **Unlock Mode** of Monitor for different lock types.
  - Power-on-to-unlock type:Unlock Mode=0 (by default)
  - Power-off-to-unlock type:Unlock Mode=1

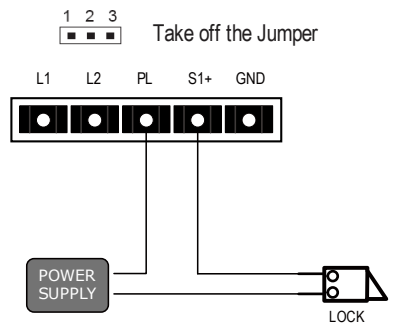

## Unlock parameter setting(set in monitor)

- On main menu page, touch **[Logo]** icon to enter **About** page.
- When the screen stay in **About** page, press  **UNLOCK** button on front panel and hold for 2 seconds.
- A keypad is shown.

Refer to the followings:

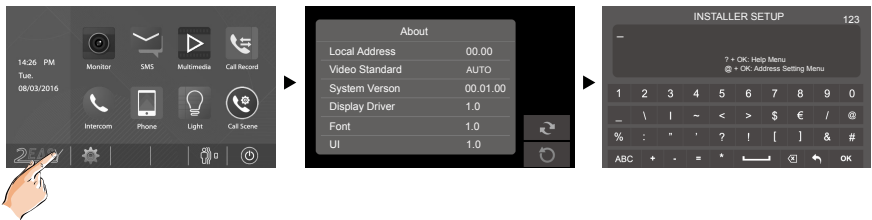

Note:

- 1.must connect DT611(F)/MK correctly before setting.
- 2.the parameter will be saved in DT611(F)/MK automatically,so you need only set on one monitor.

## Multi Door Stations Connection

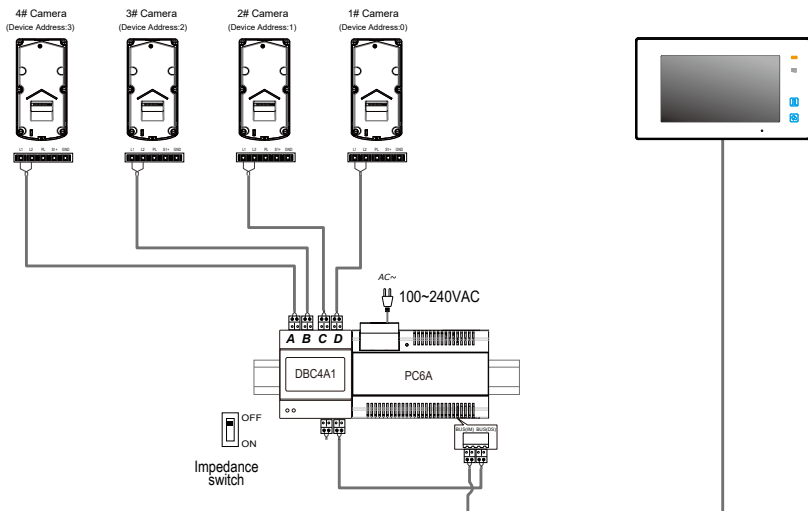

# Multi Monitors Connection

## Basic IN-OUT Wiring Mode

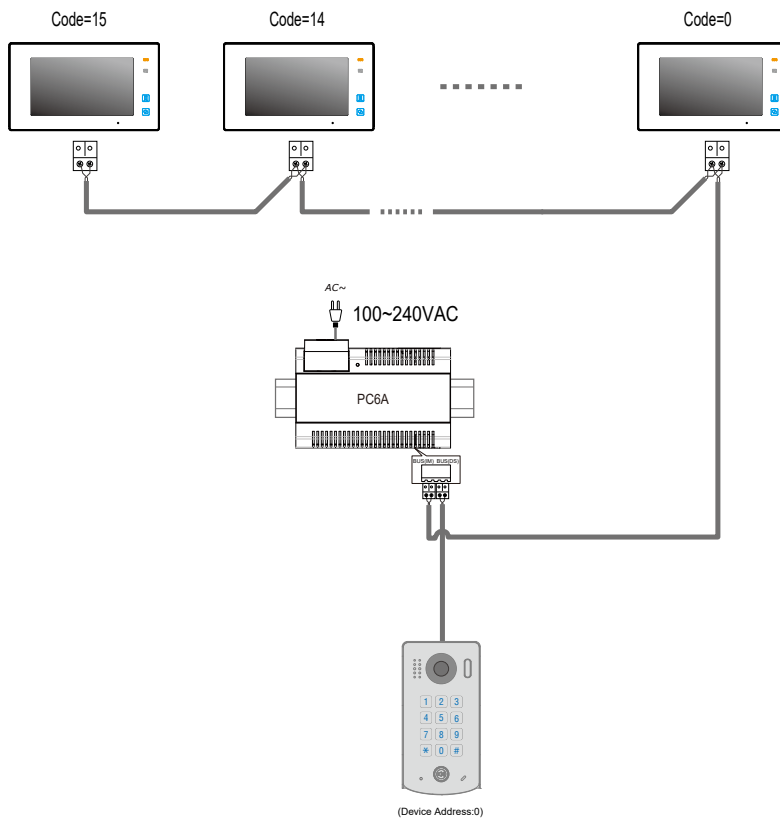



# With DBC4A1 Wiring Mode

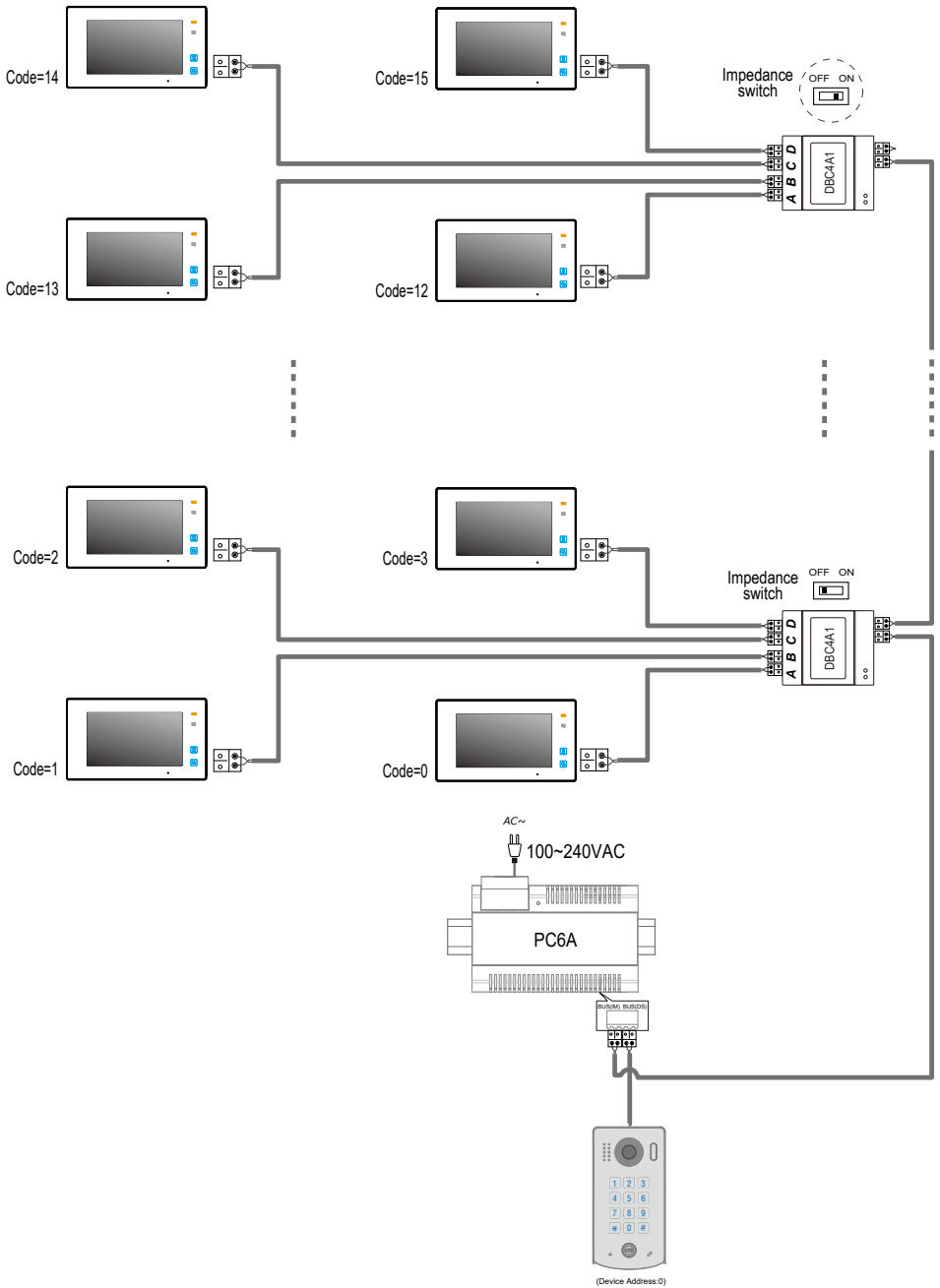

## 5. Pan-tilt & Zoom

Note that this function requires the monitor with fish-eye function to support.

It is available to adjust the display mode for viewing images at a fish-eye door station by using the 5 direction pad button.

When an image at a door station is displayed, move to the desired position by touching ▲ ▼ ● ◀ ▶ on the screen to view the image in zoom mode.

Note: The edge of pantilt image will not be displayed.

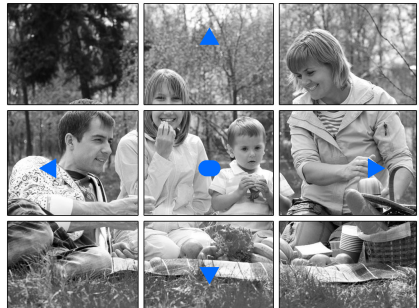

Screen of monitor

**Here are some examples:**

Touch ● icon to zoom the center position.

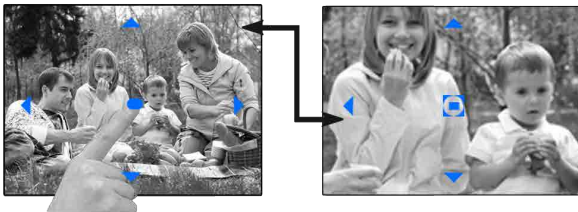

## 6. Functions Setting Up

This section explains the settings of each function, please refer to the following table:

About the setting mode:

Input the master code to switch to the setting mode, and input the corresponding setting code to perform the settings for the function you want. After settings have been made, input the following setting codes to continue the setting operation. Press "\*" to exit the setting mode.



- The example is set \* as cancel button and # as confirm button, please refer to \*/# function setting for detail information.
- Forbid to slide to touch the digital keypad, it may cause mistaken key, the correct operation is using your finger to press the digital you desired.
- You should press "confirm" button after finish inputting the code number each time, otherwise, the operation will be canceled automatically in 10s.

Order	Setting items	Setting range	Default value	Setting code
1	Reset all settings	-	1,2,3,4	00
2	Setting the master code	1 ~ 12 digits Valid keys:0 ~ 9	1234	01
3	Setting the key illumination time	10 to 99 seconds/ 0(continually lit)	10 seconds	02
4	Setting the unlock time	1 to 99 seconds	1 seconds	03
5	Setting the unlock mode	0:opened/1:closed	opened	04
6	Operation tone settings	0:on/1:off	on	05
7	Reset code settings	-	1,2,3,4	06
8	*&# function settings	0:Normal/1:Reverse	Normal	07
9	Language	Valid keys:0~9	Enable	08
10	Voice Volume	Valid keys:0~9	5	09

11	IMC Volume Adjust	Valid keys:0~9	7	10
12	SPK Volume Adjust	Valid keys:0~9	4	11
13	Device Address	Valid keys:0~3	0	12
14	Night Light Level	Valid keys:0~5	4	13
15	Reserve( <u>not used</u> )	Reserve	Reserve	14~17
16	Temporary(Single Use only) Password for relay1	1 ~ 12 digits Valid keys:0~9	-	18
17	Temporary(Single Use only) Password for relay2	1 ~ 12 digits Valid keys:0~9	-	19
18	Setting the code for user group 1	1 ~ 12 digits Valid keys:0~9	-	20~59
19	Setting the code for user group2	1 ~ 12 digits Valid keys:0~9	-	60~99
20	Work Mode	0: Apartment/1:Villa	1(villa)	100
21	Call Address	Valid keys: 0 - 9	Villa:00,16 Apartment:00~31	101



Each operation is indicated by the lighting up of the LED\_ POW , and by the sounding of the buzzer.

Input the master code. (Default: [ 1 2 3 4 ] +[#] )	Status of LED_POW (white,slow flash)  Beep+, Beep
--	--

1.Reset all settings	2.Setting the master code (Default : 1234)	3.Setting the key illumination time (Default : 10s)	4.Setting the unlock time (Default : 1s)
----------------------	---	--	---

Input the setting code. <b>00+#</b>
Status of LED_POW (white,slow flash)  Beep+, Beep

Input the setting code. <b>01+#</b>
Status of LED_POW (white,slow flash)  Beep+, Beep

Input the setting code. <b>02+#</b>
Status of LED_POW (white,slow flash)  Beep+, Beep

Input the setting code. <b>03+#</b>
Status of LED_POW (white,slow flash)  Beep+, Beep

Inputting of code <b>1234+#</b>
Status of LED_POW (off)  Beep+

Inputting of new master code (ex.: 4321)(1~12 digits) <b>4321+#</b>
Status of LED_POW (white,slow flash)  Beep+

Inputting of code (ex.: 10) range:00 or 10~99 <b>10+#</b>
Status of LED_POW (white,slow flash)  Beep+

Inputting of code (ex.: 09) range:01~99 <b>09+#</b>
Status of LED_POW (white,slow flash)  Beep+

<ul style="list-style-type: none"> <li>- When the “ * cancel” key is pressed, the LED_POW will off, the buzzer beeps, and the system exits the setting mode.</li> <li>- When there isn't any operation in 10s, the LED_POW will off, the buzzer beeps, and the system exits the setting mode.</li> <li>- When setting failure, the LED_POW will off, the buzzer beeps rapidly.</li> </ul>	Status of LED_POW (off)  Beep, Beep+
---	---

- All settings will restore to their default value.  
- When power on or activate the reset all setting item, the keypad checking will carry out, during this time, the LED\_POW will on--off--on, and the touching operation is forbidden, after finish checking, the LED\_POW will off and sent out a long sound of beep

- The master code is allowed 1~12 digits, the same code cannot be set for both the user code and the master code, it is recommended that you modify the default master code.

- If the key illumination time is set to 00, the key illumination will light up all the time when power on.  
- If the key illumination time is set to 10~99, the key illumination will light up for 10~99 seconds. At this mode, the key illumination lights off in standby mode, touching any digital key can illuminate, but this is the invalid digital.

- The unlock time can be set on both monitor and door station, and the valid value is the number you set last time.



5.Setting the unlock mode (Default : 0(opened))	6.Setting operation tone (Default : ON)	7.Reset code setting	8.*&# function setting (Default : Normal)
--	--	----------------------	--

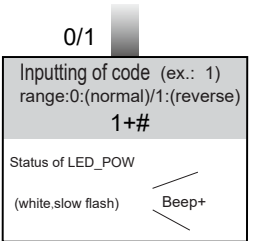
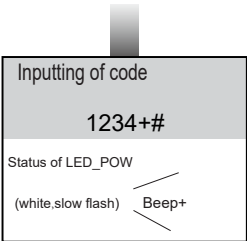
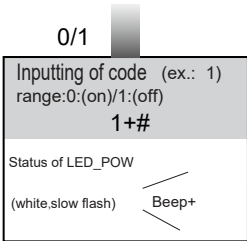
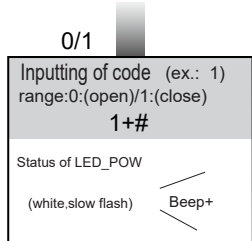
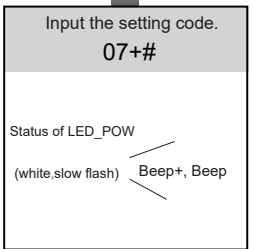
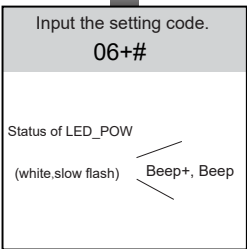
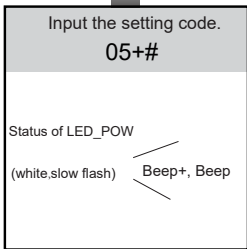
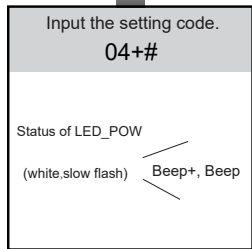

- |   |  |   |
|---|--|---|
| <ul style="list-style-type: none"> <li>- When the " * cancel" key is pressed, the LED_POW will off, the buzzer beeps, and the system exits the setting mode.</li> <li>- When there isn't any operation in 10s, the LED_POW will off, the buzzer beeps, and the system exits the setting mode.</li> <li>- When setting failure, the LED_POW will off, the buzzer beeps rapidly.</li> </ul> | <table border="1"> <tr> <td>Status of LED_POW<br/>(off)  Beep, Beep+</td> </tr> </table> | Status of LED_POW<br>(off)  Beep, Beep+ |
| Status of LED_POW<br>(off)  Beep, Beep+   |  |   |

- The unlock mode can be set on both monitor and door station, and the valid value is the number you set last time.

- When the operation tone is set to 0,pressing the digital keypad will sent out a sound of beep.  
- When the operation tone is set to 1,pressing the digital keypad will blink one time.

- Cancel all the passwords except the master code.  
- Restore the master code to default value(1,2,3,4)

- When the item is set to 0,press the \* button to cancel the input, and press the # button to confirm the input.  
- When the item is set to 1,press the # button to cancel the input, and press the \* button to confirm the input .



9. Language (Default : 2)	10.Voice Volume (Default : 5)	11.IMC volume adjust setting (Default:7)	12.SPK volume adjust setting (Default:4)
------------------------------	----------------------------------	---	---

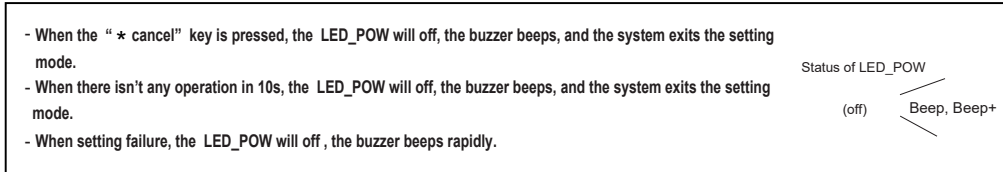
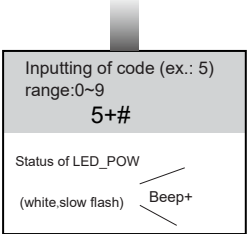
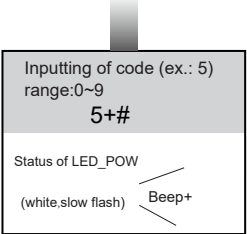
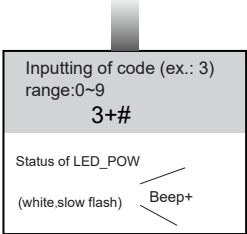
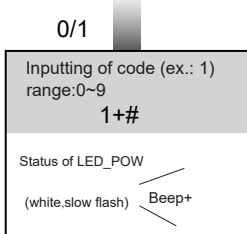
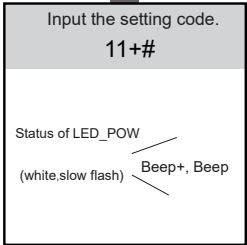
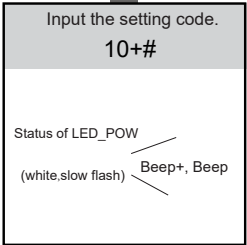
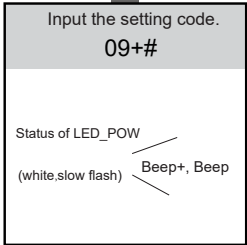
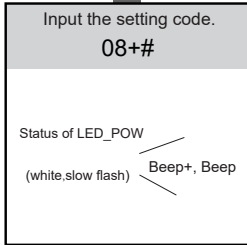

- Unlock via password is still available even when the door station is talking.
- When door station is talking, you can enter the Master code (the LED turns white upon that) to activate the volume adjusting function:
  - \* MIC adjustment: 1 (up), 4 (down);
  - \* Sleaker adjustment: 3 (up), 6 (down).



13. Device address setting (Default : 0)	14.Night light level setting (Default : 4)	15.Temporary(Single Use only) Password for relay1	16.Temporary(Single Use only) Password for relay2
---	---	---	---

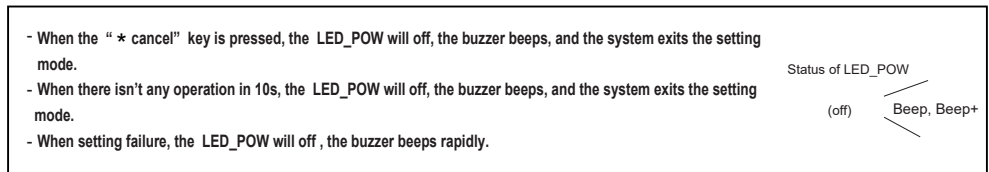
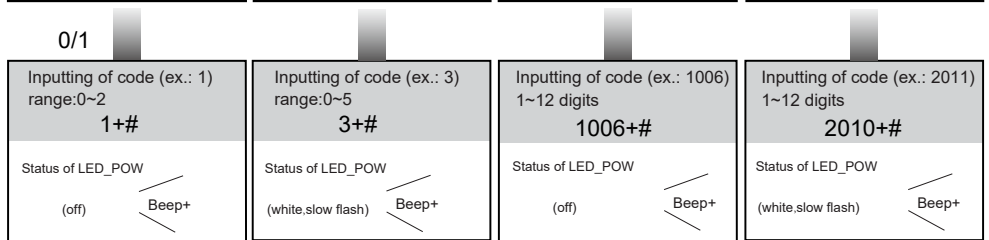
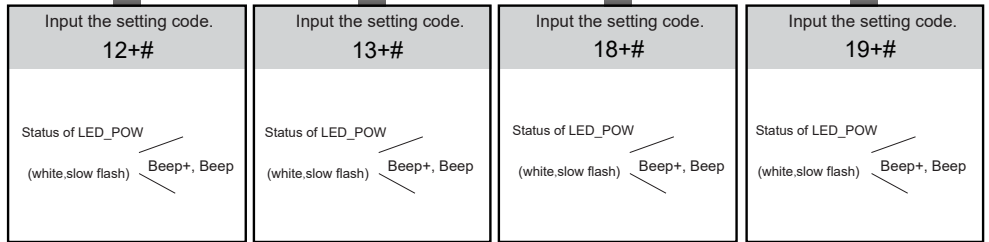

- Device address Settings:  
0(device address:0),1(device address:1),2(device address:2), 3(device address:3).

- Night Light Level:0~5.  
-The higher the number, the brighter the night lights.

- When input the correct temporary password to release the door, the system will clear the temporary password after 60 seconds automatically. But you should know that the password is valid within 60 seconds after inputting the correct temporary password

- The temporary1 is used to release the first lock, and the temporary 2 is used to release the second lock (the second lock need external device to support).
- If the password length exceeds 12 digits, the system will sent out the sound of "beep,beep,beep,beep", and the digitals you input before will be cleared at the same time.
- The temporary code can not be set the same as the master code and user code





17. Setting the code for user group1	18. Setting the code for user group2	19. Work mode setting (Default: 1/villa)	20. Call address setting (Default: villa:00, 16; apartment:00~31)
--------------------------------------	--------------------------------------	---	--

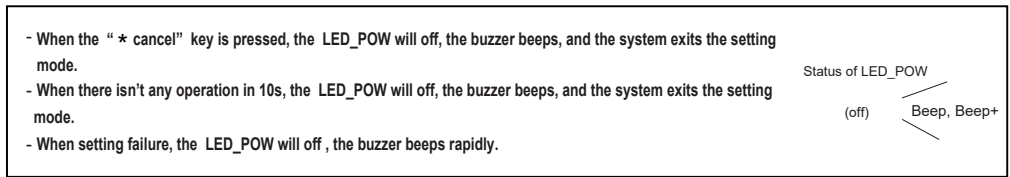
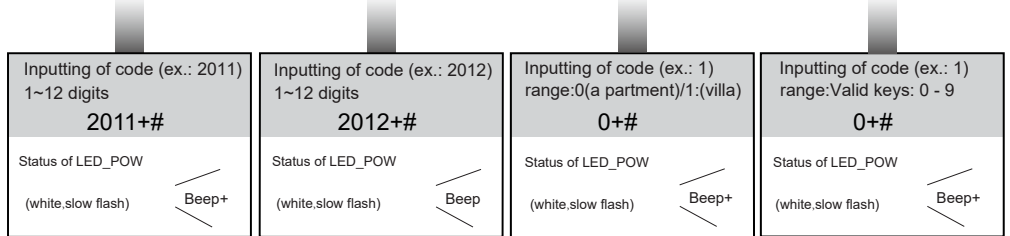
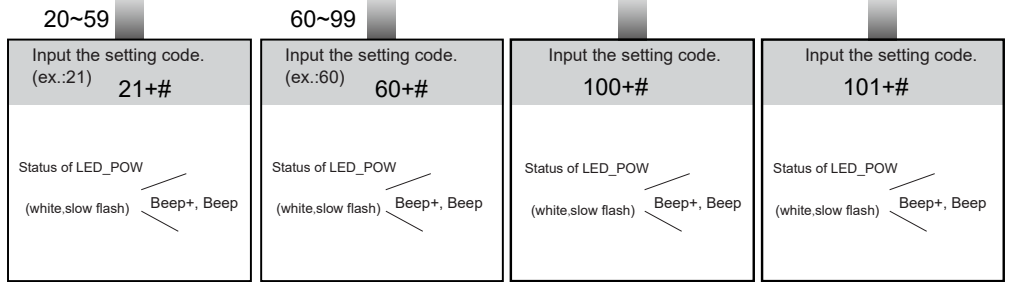

- The user code group1 is used to release the first lock, and the user code group2 is used to release the second lock (the second lock need external device to support).
- The user code group1 and user code code group2 can contain 40 group passwords
- If the password length exceeds 12 digits, the system will sent out the sound of “beep,beep,beep,beep”, and the digitals you input before will be cleared at the same time.
- The user code can not be set the same as the master code and temporary code.

- Work mode setting:  
0(a partment)/1:(villa).

- When the work mode is villa, the call address:00 or 16.
- When the work mode is a partment, the range of call address:00~31.

## 7.Unlock Operations

### Unlocking of user code

When the registered user code has been input using the keypad (1~12 digits), the LED background indicator lights up, the buzzer sounds,and the electric door strike is unlocked.(note that you should press "#" button(if "#" button is set to confirm button) after input the unlock code)

- The time interval during which the button must be pressed is approximately 10 seconds. If the time interval exceeds approximately 10 seconds, the input value will be cleared.
- If you make a mistake when inputting the user code,press the" cancel" button and input the user code again.
- The release function is forbidden and the input operation is disabled for 60 seconds if 10 times incorrect access codes are continuously attempted. During this time,the buzzer will continuously sound about 8 times.



1. During calling,pressing "cancel" button can cancel the calling
2. If input the incorrect access code,the buzzer will sound of beep,beep,beep

## 8.Specifications

- Power Supply : DC 24V ;
- Power Consumption: Standby 15mA; Working status 105mA;
- Camera: Color CMOS, 2.0 Mega pixel  
1/2.7" fisheye camera,170° wide angle;
- Unlocking time: 1~99s
- Lock Power supply: 12Vdc, 280mA(Internal Power);
- Number of relay circuits: 2(the second lock need external device to support)
- Mounting: Surface mounting(DT611/MK)  
Flush mounting (DT611F/MK)
- Working temperature: -15°C ~ +55°C
- Dimension: 182(H)×93(W)×44(D)mm(DT611/MK)  
220(H)×120(W)×50(D)mm(DT611F/MK)

## 9.Cables Requirements

The maximum distance of the wiring is limited in the DT system. Using different cables may also affect the maximum distance which the system can reach.

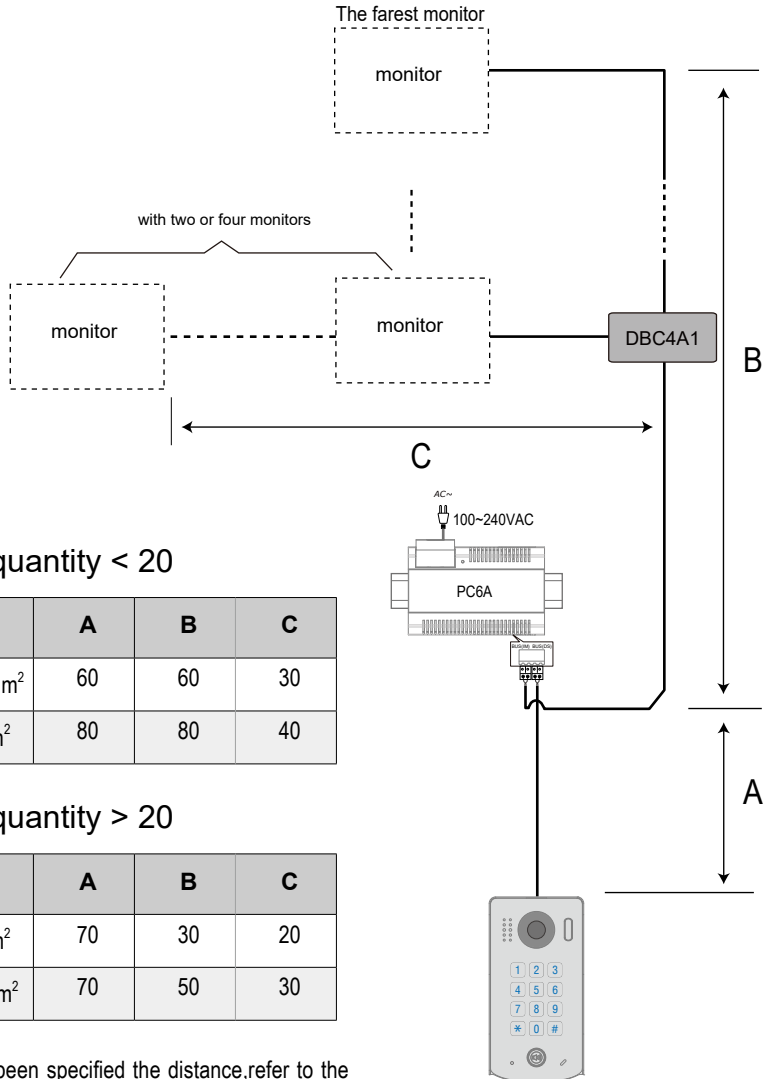

When Monitor quantity < 20

Cable Usage	A	B	C
Twisted cable 2x0.75 mm <sup>2</sup>	60	60	30
Twisted cable 2x1 mm <sup>2</sup>	80	80	40

When Monitor quantity > 20

Cable Usage	A	B	C
Twisted cable 2x1 mm <sup>2</sup>	70	30	20
Twisted cable 2x1.5 mm <sup>2</sup>	70	50	30

Note:If the monitor has been specified the distance,refer to the parameter.

## 10. Precautions

- Please clean the unit with soft cotton cloth, don't use the organic impregnant or chemical clean agent. If necessary, please use a little pure water or dilute soap water to clean the dust.
- The unit is weather resistant. However do not spray high pressure water on access control keypad directly. Excessive moisture may cause problems with the unit.
- You must use the right adaptor which is supplied by the manufacture or approved by the manufacture..
- Pay attention to the high voltage inside the products, please refer service only to a trained and qualified professional.

The design and specifications can be modified without notice to the user. Right to interpret and copyright of this manual are reserved.